

PART#C424/42/F/SM/R/FE 1/8" Cable, 42H, Flange, Rcvr, Flush Fitting

- Use as an end post.

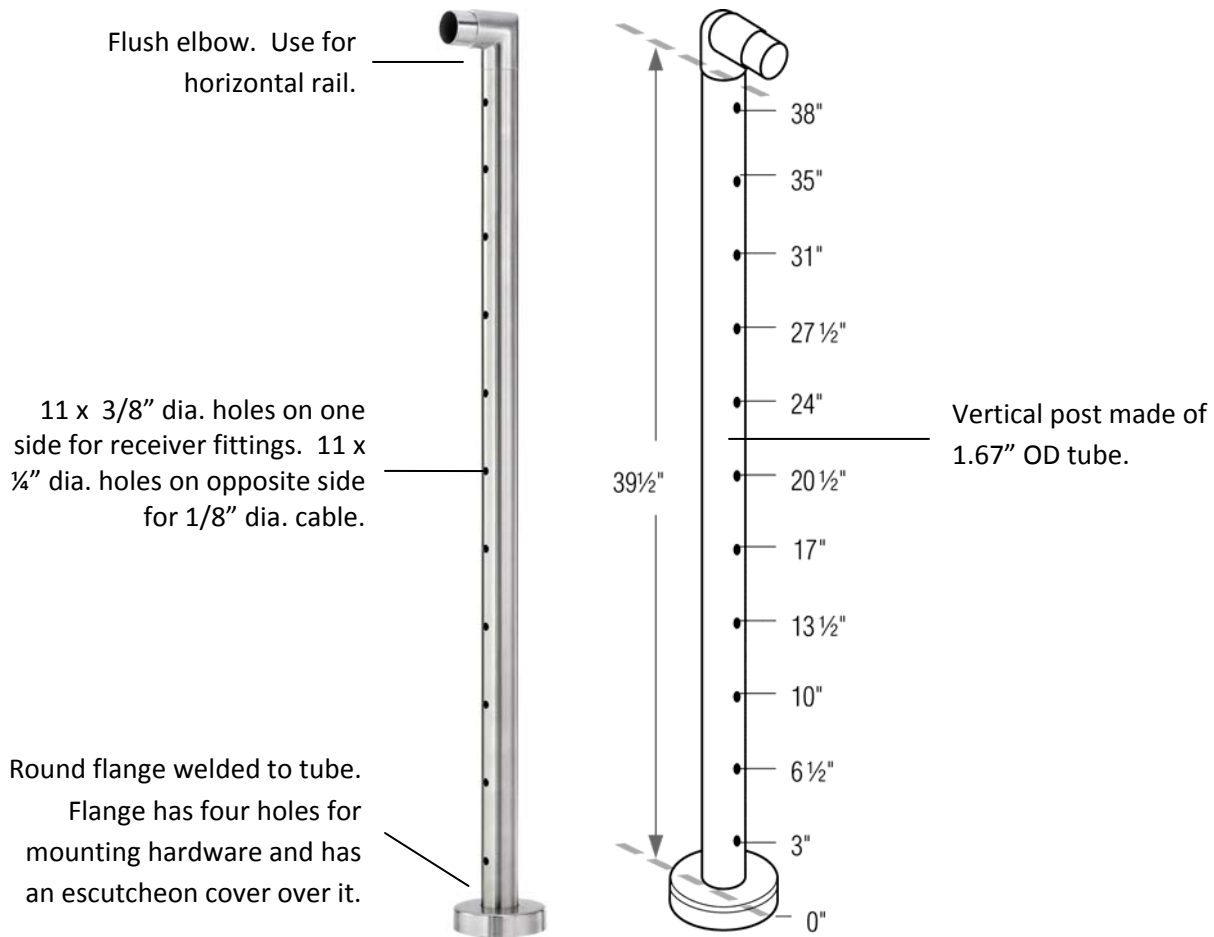

MATERIAL, FINISHES, USAGE		
	304 SST	316 SST
Polished		
Circular Satin		√
Clear Coat		
Indoor		√
Outdoor		√

MATERIAL CARE	
Stainless Steel	Use metal cleaner and apply with a damp, soft cloth.

INSTALLATION	Lift flange canopy. Bolt flange to the ground using hardware appropriate for the surface that it is being mounted on. Lower canopy and secure with silicone (optional).
HARDWARE INCLUDED	---
USE TOGETHER WITH	1.67" OD tube for handrail (A114) and 1/8" cable rail assemblies.