

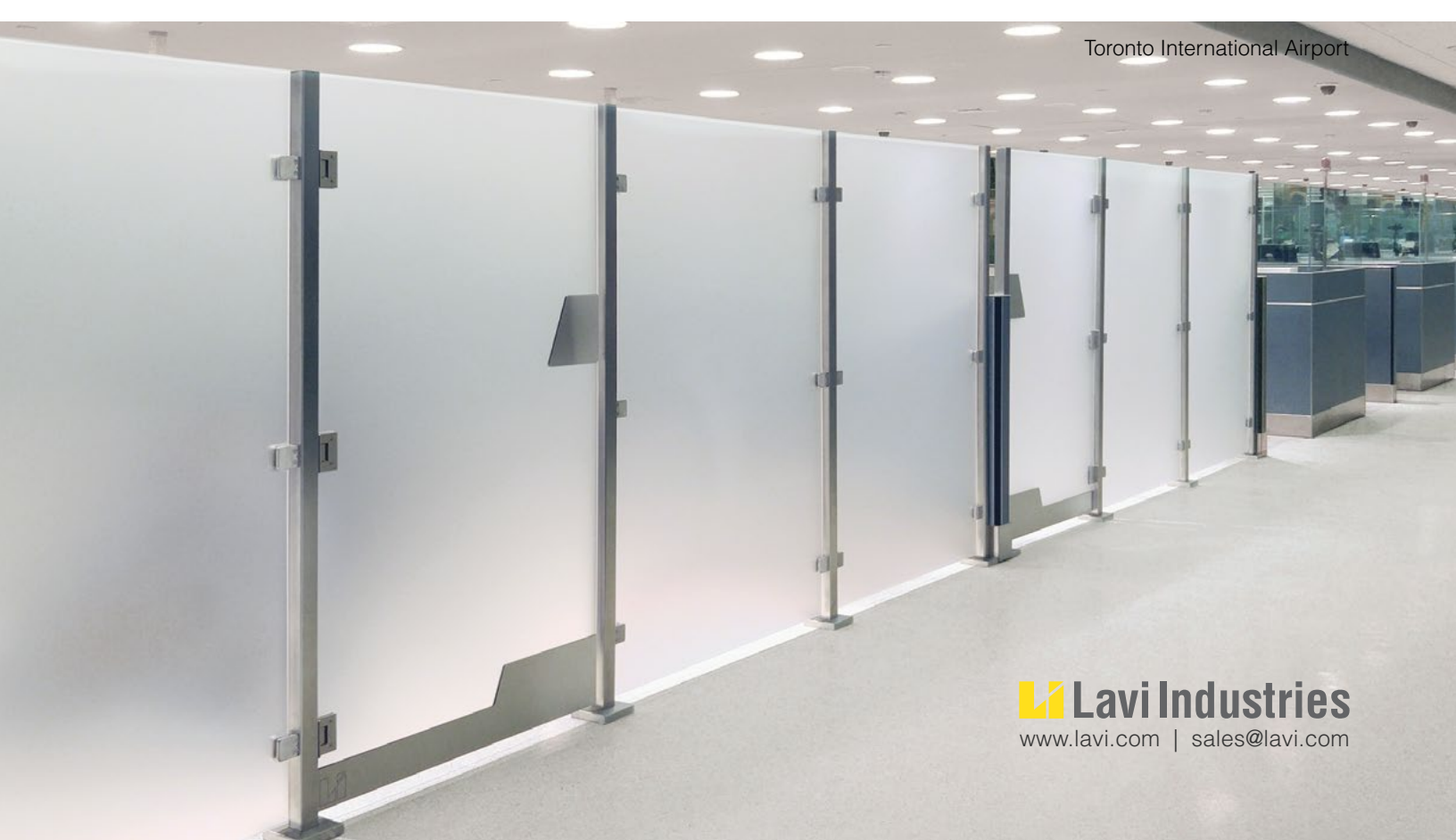

Federal Inspection Station, San Diego International Airport

316-GRADE STAINLESS STEEL

Architectural Partition Walls and Gates



Toronto International Airport

Our modular, stainless steel and glass/plexi partition wall system installs quickly and easily.



Cut Flanges permit mounting flush to walls.

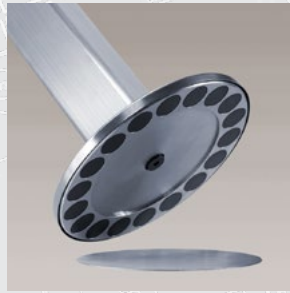

Eliminate core drilling with a **Magnetic Mount**.



Push Plates protect gates.



Kick Plates protect gates.

- Permanent or removable installation.
- Magnetic-base option makes installation quick and easy — No floor drilling required.
- Locking gates provide secure access control.
- Modular system includes 4 standard heights — 42", 48", 60", and 72" — to fit almost any space or need.
- Available frosted panels provide privacy.
- Corrosion-resistant, 316-grade stainless steel creates an architectural statement both indoors and out.

Provide security, access control, and pedestrian flow.



4 heights, 3 mounting options, endless possibilities.

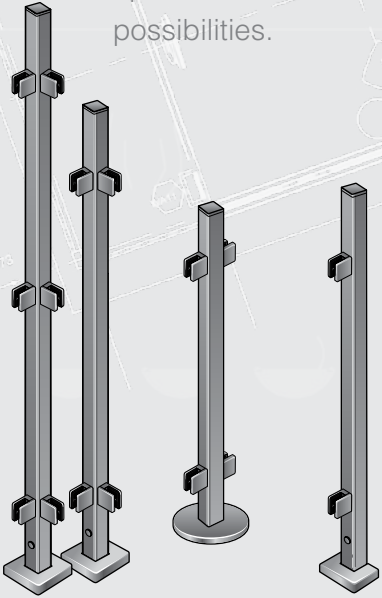

Flange Mount

Magnetic Mount

Cut Flange Mount

Table rotates to any angle, providing a convenient surface.

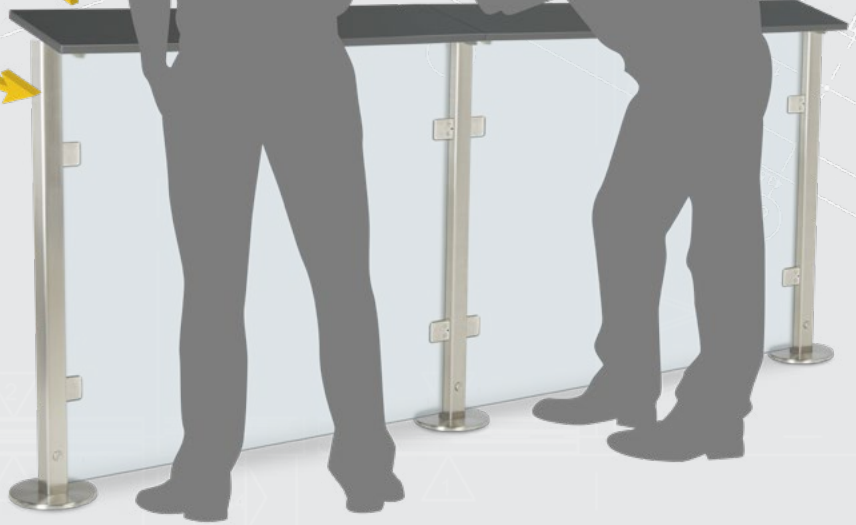

Optional Table-Top

Perfect for food and beverage service

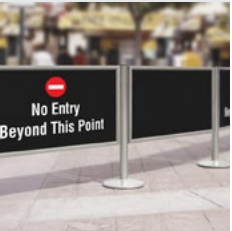

Looking for a portable solution?
Check out our Post & Panel system.

[VIEW NOW](#)



CATSA, Edmonton International Airport



Customs and Border Patrol, DFW International Airport



San Diego International Airport



Montréal-Pierre Elliott Trudeau International Airport

TEMPERED GLASS | FROSTED PLEXI | WALLS & GATES

A few options. Unlimited possibilities.



End Post

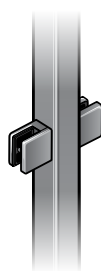

Center Post

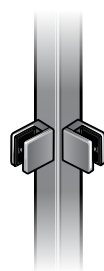

Corner Post



Receiver Post

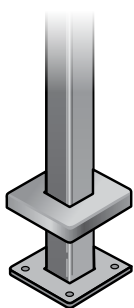

Flange Mount

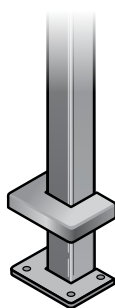

Cut Flange Mount



Magnetic Mount

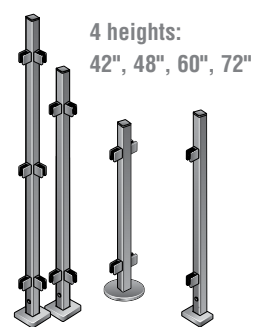

4 heights:
42\", 48\", 60\", 72\"

POSTS

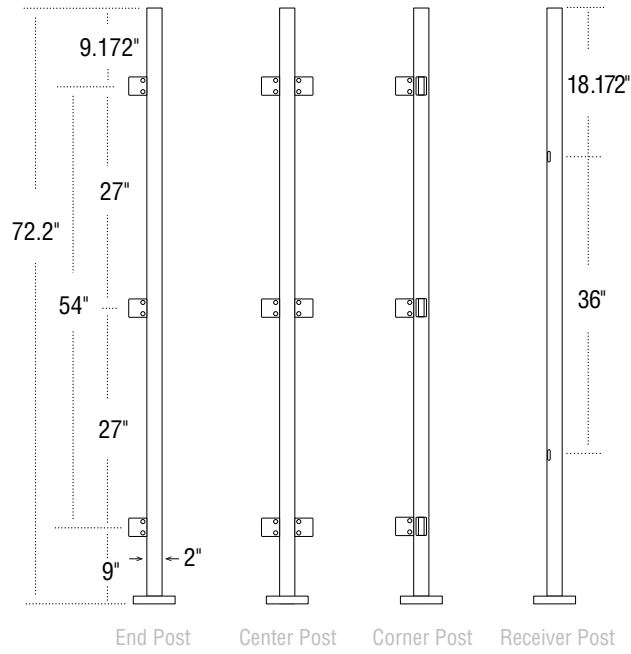

72-INCH TALL POSTS

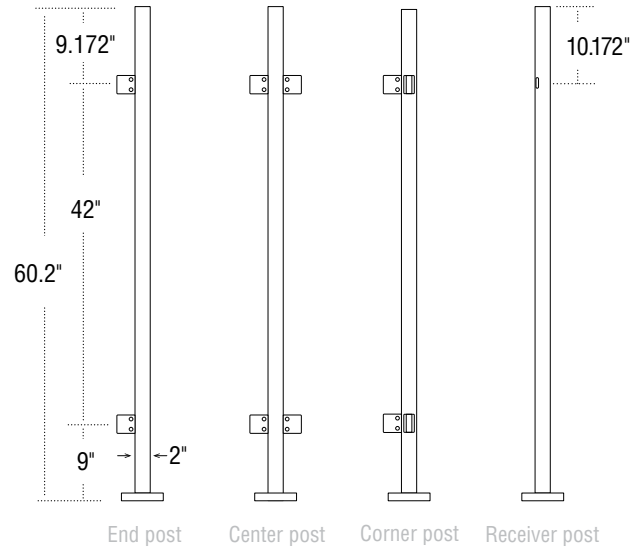

60-INCH TALL POSTS

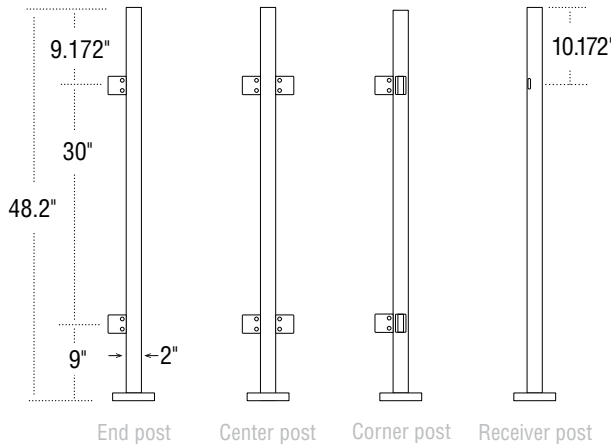

48-INCH TALL POSTS

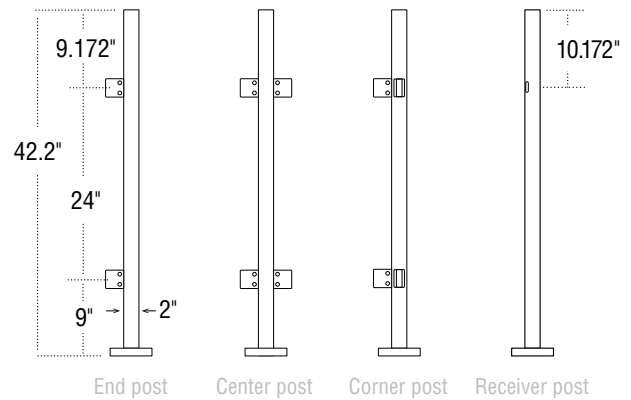

42-INCH TALL POSTS

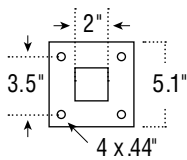

Flange

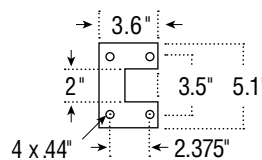

Cut Flange

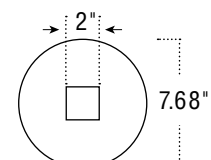

Magnetic (on 42" and 48" Posts only)

MOUNTING CONDITIONS

POSTS

72" POSTS

Part Number	Height	Position	Mount
49-170/72/F/E	72"	End	Flange
49-170/72/F/C	72"	Center	Flange
49-170/72/F/L	72"	Corner	Flange
49-170/72/F/R	72"	Receiver	Flange
49-170/72/CF/E	72"	End	Cut Flange
49-170/72/CF/C	72"	Center	Cut Flange
49-170/72/CF/L	72"	Corner	Cut Flange
49-170/72/CF/R	72"	Receiver	Cut Flange

60" POSTS

Part Number	Height	Position	Mount
49-170/60/F/E	60"	End	Flange
49-170/60/F/C	60"	Center	Flange
49-170/60/F/L	60"	Corner	Flange
49-170/60/F/R	60"	Receiver	Flange
49-170/60/CF/E	60"	End	Cut Flange
49-170/60/CF/C	60"	Center	Cut Flange
49-170/60/CF/L	60"	Corner	Cut Flange
49-170/60 /CF/R	60"	Receiver	Cut Flange

48" POSTS

Part Number	Height	Position	Mount
49-170/48/F/E	48"	End	Flange
49-170/48/F/C	48"	Center	Flange
49-170/48/F/L	48"	Corner	Flange
49-170/48/F/R	48"	Receiver	Flange
49-170/48/CF/E	48"	End	Cut Flange
49-170/48/CF/C	48"	Center	Cut Flange
49-170/48/CF/L	48"	Corner	Cut Flange
49-170/48/CF/R	48"	Receiver	Cut Flange
49-170/48/M/E	48"	End	Magnetic
49-170/48/M/C	48"	Center	Magnetic
49-170/48/M/L	48"	Corner	Magnetic
49-170/48/M/R	48"	Receiver	Magnetic

42" POSTS

Part Number	Height	Position	Mount
49-170/42/F/E	42"	End	Flange
49-170/42/F/C	42"	Center	Flange
49-170/42/F/L	42"	Corner	Flange
49-170/42/F/R	42"	Receiver	Flange
49-170/42/CF/E	42"	End	Cut Flange
49-170/42/CF/C	42"	Center	Cut Flange
49-170/42/CF/L	42"	Corner	Cut Flange
49-170/42/CF/R	42"	Receiver	Cut Flange
49-170/42/M/E	42"	End	Magnetic
49-170/42/M/C	42"	Center	Magnetic
49-170/42/M/L	42"	Corner	Magnetic
49-170/42/M/R	42"	Receiver	Magnetic

PROJECT LAYOUT

WALLS

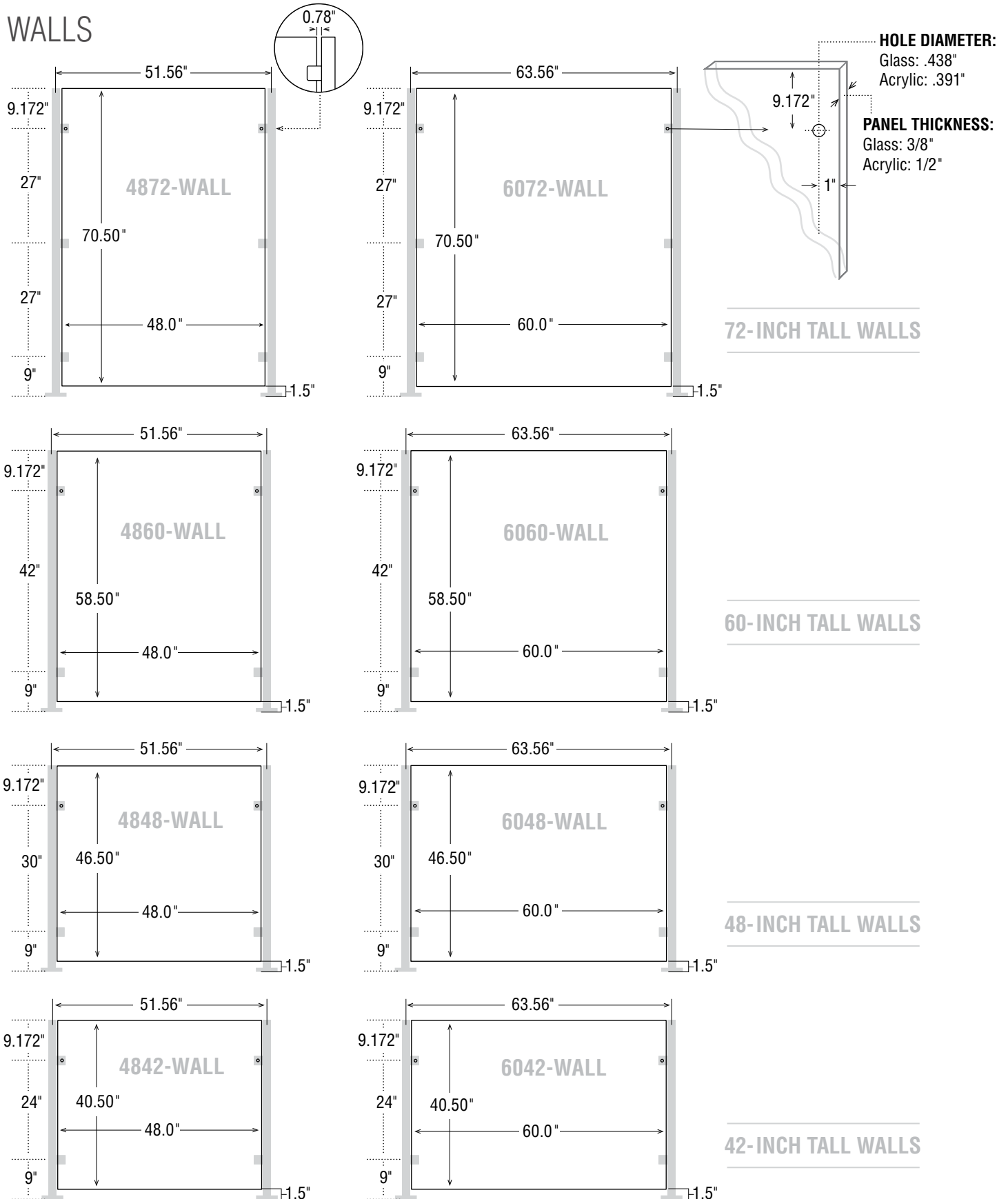

WALLS

3/8" TEMPERED GLASS

Part Number	Size	Finish	Thickness
70-4872/3	48" x 72"	Clear	3/8"
70-6072/3	60" x 72"	Clear	3/8"
70-4860/3	48" x 60"	Clear	3/8"
70-6060/3	60" x 60"	Clear	3/8"
70-4848/3	48" x 48"	Clear	3/8"
70-6048/3	60" x 48"	Clear	3/8"
70-4842/3	48" x 42"	Clear	3/8"
70-6042/3	60" x 42"	Clear	3/8"

1/2" ACRYLIC PANELS

Part Number	Size	Finish	Thickness	Part Number	Size	Finish	Thickness	Part Number	Size	Finish	Thickness
80-A4872/4	48" x 72"	Clear	1/2"	84-A4872/4	48" x 72"	Frosted 1 Side	1/2"	86-A4872/4	48" x 72"	Frosted 2 Sides	1/2"
80-A6072/4	60" x 72"	Clear	1/2"	84-A6072/4	60" x 72"	Frosted 1 Side	1/2"	86-A6072/4	60" x 72"	Frosted 2 Sides	1/2"
80-A4860/4	48" x 60"	Clear	1/2"	84-A4860/4	48" x 60"	Frosted 1 Side	1/2"	86-A4860/4	48" x 60"	Frosted 2 Sides	1/2"
80-A6060/4	60" x 60"	Clear	1/2"	84-A6060/4	60" x 60"	Frosted 1 Side	1/2"	86-A6060/4	60" x 60"	Frosted 2 Sides	1/2"
80-A4848/4	48" x 48"	Clear	1/2"	84-A4848/4	48" x 48"	Frosted 1 Side	1/2"	86-A4848/4	48" x 48"	Frosted 2 Sides	1/2"
80-A6048/4	60" x 48"	Clear	1/2"	84-A6048/4	60" x 48"	Frosted 1 Side	1/2"	86-A6048/4	60" x 48"	Frosted 2 Sides	1/2"
80-A4842/4	48" x 42"	Clear	1/2"	84-A4842/4	48" x 42"	Frosted 1 Side	1/2"	86-A4842/4	48" x 42"	Frosted 2 Sides	1/2"
80-A6042/4	60" x 42"	Clear	1/2"	84-A6042/4	60" x 42"	Frosted 1 Side	1/2"	86-A6042/4	60" x 42"	Frosted 2 Sides	1/2"

PROJECT LAYOUT

GATES

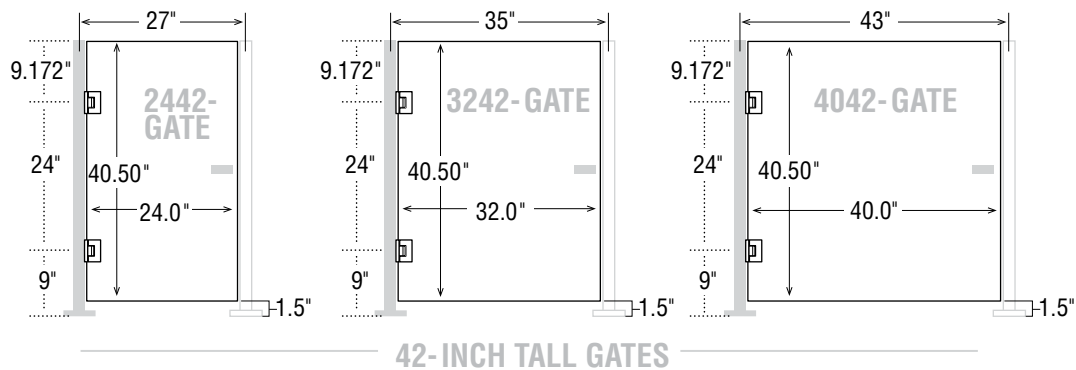
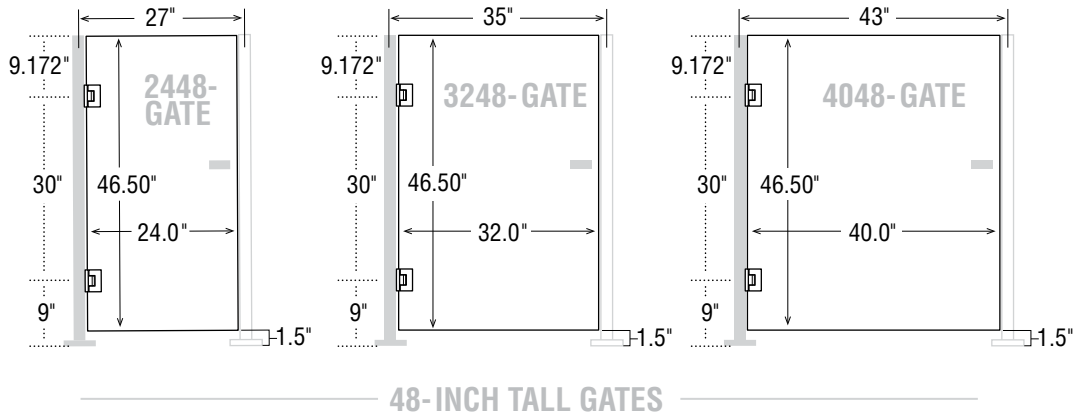
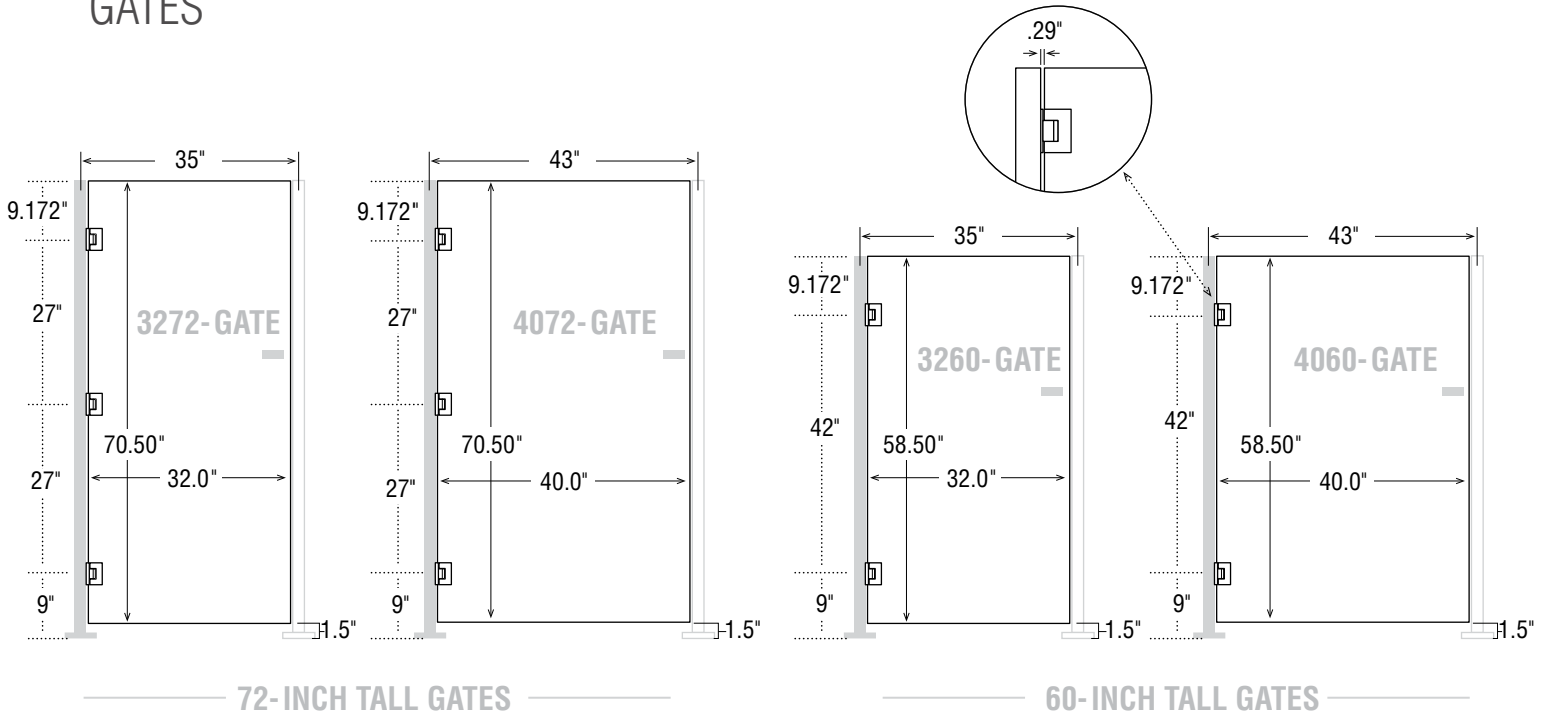

GATES

3/8" TEMPERED GLASS

Part Number	Size	Finish
70-4072/3GATE	40" x 72"	Clear
70-3272/3GATE	32" x 72"	Clear
70-4060/3GATE	40" x 60"	Clear
70-3260/3GATE	32" x 60"	Clear
70-4048/3GATE	40" x 48"	Clear
70-3248/3GATE	32" x 48"	Clear
70-2448/3GATE	24" x 48"	Clear
70-4042/3GATE	40" x 42"	Clear
70-3242/3GATE	32" x 42"	Clear
70-2442/3GATE	24" x 42"	Clear

1/2" ACRYLIC PANELS

Part Number	Size	Finish
80-A4072/4GATE	40" x 72"	Clear
80-A3272/4GATE	32" x 72"	Clear
80-A4060/4GATE	40" x 60"	Clear
80-A3260/4GATE	32" x 60"	Clear
80-A4048/4GATE	40" x 48"	Clear
80-A3248/4GATE	32" x 48"	Clear
80-A2448/4GATE	24" x 48"	Clear
80-A4042/4GATE	40" x 42"	Clear
80-A3242/4GATE	32" x 42"	Clear
80-A2442/4GATE	24" x 42"	Clear

Part Number	Size	Finish
84-A4072/4GATE	40" x 72"	Frosted 1 Side
84-A3272/4GATE	32" x 72"	Frosted 1 Side
84-A4060/4GATE	40" x 60"	Frosted 1 Side
84-A3260/4GATE	32" x 60"	Frosted 1 Side
84-A4048/4GATE	40" x 48"	Frosted 1 Side
84-A3248/4GATE	32" x 48"	Frosted 1 Side
84-A2448/4GATE	24" x 48"	Frosted 1 Side
84-A4042/4GATE	40" x 42"	Frosted 1 Side
84-A3242/4GATE	32" x 42"	Frosted 1 Side
84-A2442/4GATE	24" x 42"	Frosted 1 Side

Part Number	Size	Finish
86-A4072/4GATE	40" x 72"	Frosted 2 Sides
86-A3272/4GATE	32" x 72"	Frosted 2 Sides
86-A4060/4GATE	40" x 60"	Frosted 2 Sides
86-A3260/4GATE	32" x 60"	Frosted 2 Sides
86-A4048/4GATE	40" x 48"	Frosted 2 Sides
86-A3248/4GATE	32" x 48"	Frosted 2 Sides
86-A2448/4GATE	24" x 48"	Frosted 2 Sides
86-A4042/4GATE	40" x 42"	Frosted 2 Sides
86-A3242/4GATE	32" x 42"	Frosted 2 Sides
86-A2442/4GATE	24" x 42"	Frosted 2 Sides

GATE ACCESSORIES

Part Number	Product	Description
49-KP01/PR	Kick Plate Set	One pair for single gate, front and back.
49-PP01/PR	Push Plate Set	One pair for single gate, front and back.
44-SL01/SET	Sliding Latch, 6"	Latch plus Latch Plate (6" x .75")
44-SL02/SET	Sliding Latch, 8"	Latch plus Latch Plate (8" x .75")
44-GL01	Key Lock Gate Latch	Locking Latch with Keys

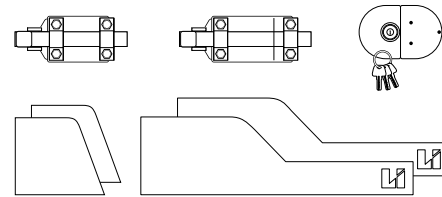

PROJECT LAYOUT